

1. Estimate the area of the figure.

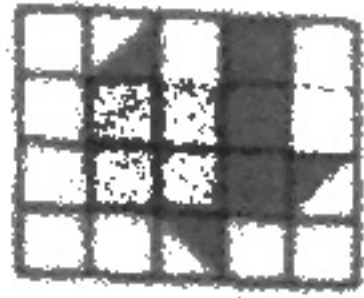

5. What is the area of the polygon?

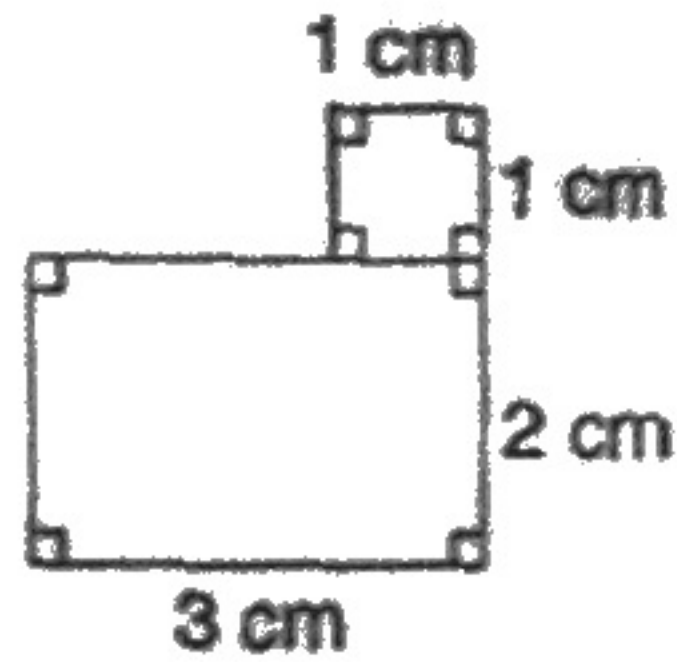

2. Find the area of the rectangle.



6. Estimate the area of the circle. Use 3 for π .

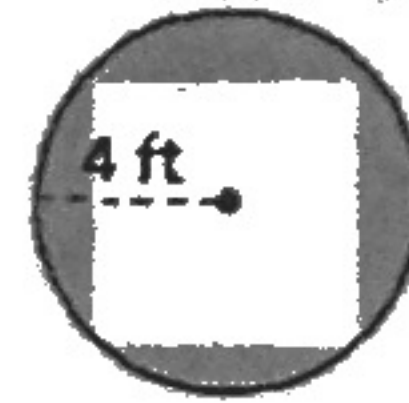

3. Find the area of the triangle.

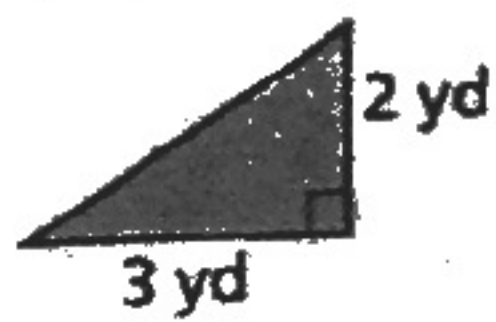

7. Find the area of the circle. Use 3 for π .



4. Find the area of the trapezoid.

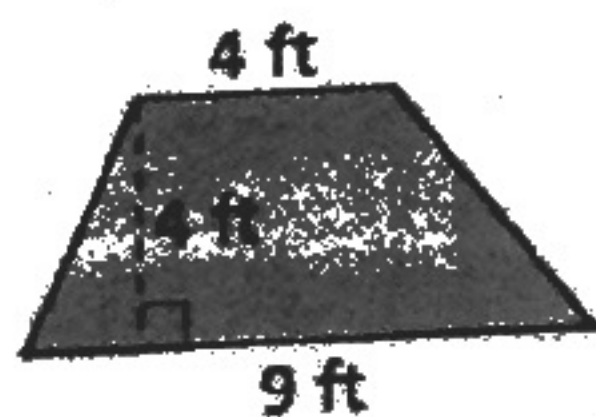

8. What type of figure is this?



9. How many faces does this figure have?

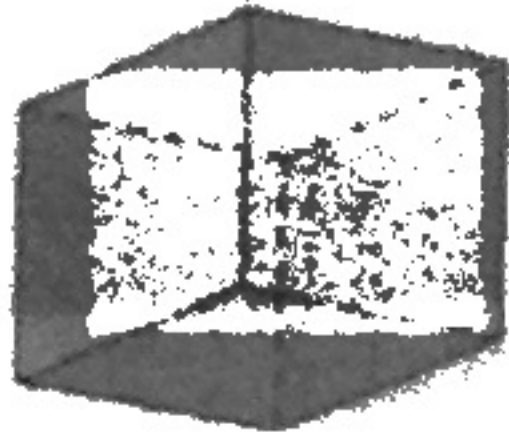

13. Find the **surface area** of this cylinder.

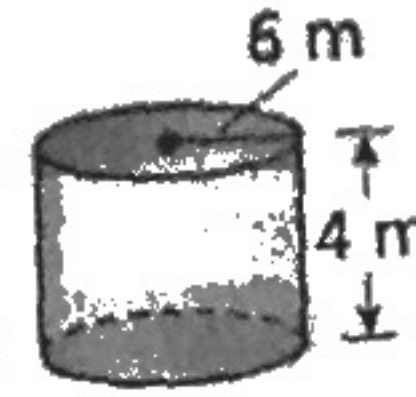

10. Find the **volume** of this rectangular prism.

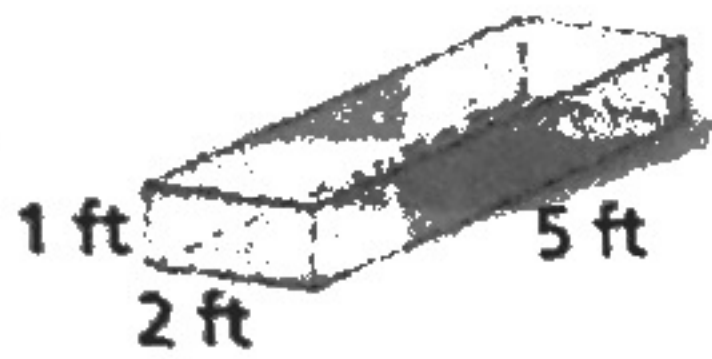

14. Find the **surface area** of this rectangular prism.

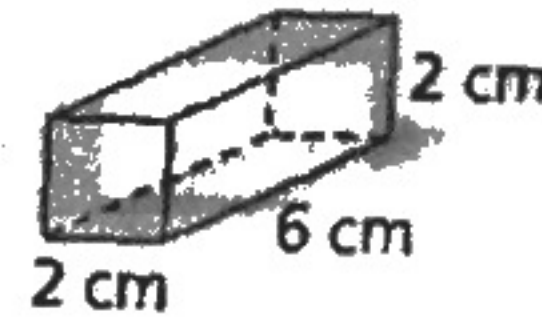

11. Find the **volume** of this triangular prism.

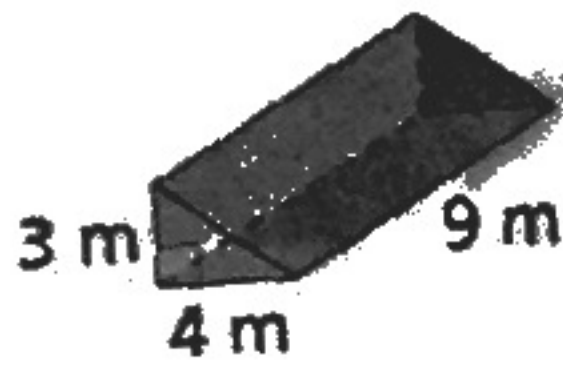

15. Find the **surface area** of this triangular prism.

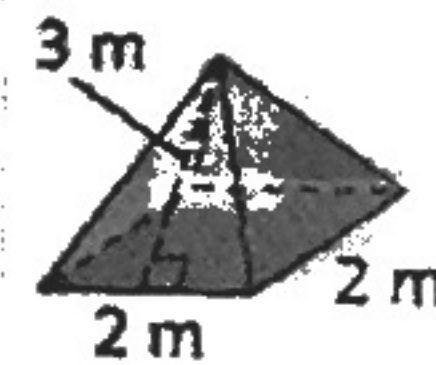

12. Find the **volume** of the cylinder. Use 3 for π .

